



<b>Display</b>	4 digits (White) + 4 digits (Green) Display Height:- White Display:- 15.3 mm Green Display:- 8 mm 7 segment digital display
<b>LED Indications</b>	1 : Output 1 ON 2 : Output 2 ON T : Tune S : Dwell Timer
<b>Keys</b>	3 keys for digital setting

INPUT SPECIFICATIONS	
<b>Input Signal</b>	Thermocouple (J,K,T,R,S) / RTD (PT100)
<b>Sampling time</b>	250 msec
<b>Input Filter (FTC)</b>	0.2 to 10.0 sec
<b>Resolution</b>	0.1 / 1° for TC/RTD input (Fixed 1° for R & S type TC input)
<b>Temperature Unit</b>	°C / °F selectable
<b>Indication Accuracy</b>	For TC inputs : 0.25% of F. S ±1°C For R & S inputs : 0.5% of F. S ±2°C (30 min of warm up time for TC input) For RTD inputs : 0.1% of F. S ±1°C

FUNCTIONAL SPECIFICATIONS	
<b>Control Method</b>	1) PID control with Auto or Self Tuning 2) ON-OFF control
<b>Proportional Band(P)</b>	1.0 to 400.0°C, 1.0 to 752.0°F
<b>Integral Time(I)</b>	0 to 9999 sec
<b>Derivative Time(D)</b>	0 to 9999 sec
<b>Cycle Time</b>	0.1 to 99.9 sec
<b>Hysteresis Width</b>	0.1 to 99.9°C
<b>Dwell Timer</b>	0 to 9999 min
<b>Manual Reset Value</b>	-19.9 to 19.9°C / °F

HEAT COOL PID SPECIFICATIONS	
<b>Control Method</b>	PID
<b>Proportional Band-Cool</b>	1.0 to 400.0°C 1.0 to 752.0°F
<b>Cycle Time-Cool</b>	0.1 to 99.9 sec
<b>Dead Band</b>	SPLL to SPHL(Programmable)

OUTPUT SPECIFICATIONS	
<b>Control Output (Relay or SSR user selectable)</b>	<b>Relay Contact :</b> 5A resistive@250V AC / 30V DC  <b>SSR Drive Output (Voltage Pulse):</b> 12V DC, 30 mA
<b>Auxiliary Output</b>	<b>Relay Contact :</b> 5A resistive@250V AC / 30V DC
POWER SUPPLY SPECIFICATIONS	
<b>Supply Voltage</b>	85 to 270V AC / DC (AC : 50 / 60 Hz )
<b>Power Consumption</b>	6 VA max@270V AC
<b>Temperature</b>	Operating : 0 to 50°C Storage : -20 to 75°C
<b>Humidity</b>	95% RH (non-condensing)
<b>Weight</b>	116 g

### 1. SAFETY PRECAUTIONS

All safety related codifications, symbols and instructions that appear in this operating manual or on the equipment must be strictly followed to ensure the safety of the operating personnel as well as the instrument.

If the equipment is not handled in a manner specified by the manufacturer it might impair the protection provided by the equipment.

Read complete instructions prior to installation and operation of the unit.

**WARNING :** Risk of electric shock.

### WIRING GUIDELINES

**WARNING :**

- To prevent the risk of electric shock power supply to the equipment must be kept OFF while doing the wiring arrangement. Do not touch the terminals while power is being supplied.
- To eliminate electromagnetic interference use short wire with adequate ratings; twists of the same in equal size shall be made. For the input and output signal lines, be sure to use shielded wires and keep them away from each other.
- Cable used for connection to power source, must have a cross section of 1mm<sup>2</sup> or greater. These wires shall have insulation capacity made of at least 1.5kV.
- When extending the thermocouple lead wires, always use thermocouple compensation wires for wiring. For the RTD type, use a wiring material with a small lead resistance (5Ω max per line) and no resistance differentials among three wires.
- A better anti-noise effect can be expected by using standard power supply cable for the instrument.

### MAINTENANCE

- The equipment should be cleaned regularly to avoid blockage of ventilating parts.
- Clean the equipment with a clean soft cloth. Do not use Isopropyl alcohol or any other cleaning agent.

### 2. INSTALLATION GUIDELINES

- This equipment, being built-in-type, normally becomes a part of main control panel and in such case the terminals do not remain accessible to the end user after installation and Internal wiring.
- Do not allow pieces of metal, wire clippings, or fine metallic fillings from installation to enter the product or else it may lead to a safety hazard that may in turn endanger life or cause electrical shock to the operator.
- Circuit breaker or mains switch must be installed between power source and supply terminals to facilitate power 'ON' or 'OFF' function. However this switch or breaker must be installed in a convenient position normally accessible to the operator.
- Use and store the temperature controller within the specified ambient temperature and humidity ranges as mentioned in this manual.

### CAUTION

- When powering up for the first time, disconnect the output connections.
- Fuse Protection : The unit is normally supplied without a power switch and fuses. Make wiring so that the fuse is placed between the mains power supply switch and the controller. (2 pole breaker fuse - rating : 275V AC,1A for electrical circuitry is highly recommended)
- Since this is a built-in-type equipment (finds place in main control panel), its output terminals get connected to host equipment. Such equipment shall also comply with basic EMI/EMC and other safety requirements like EN61326-1 and EN 61010 respectively.
- Thermal dissipation of equipment is met through ventilation holes provided on chassis of equipment. Such ventilation holes shall not be obstructed else it can lead to a safety hazard.
- The output terminals shall be strictly loaded to the manufacturer specified values / range.

### 3. MECHANICAL INSTALLATION

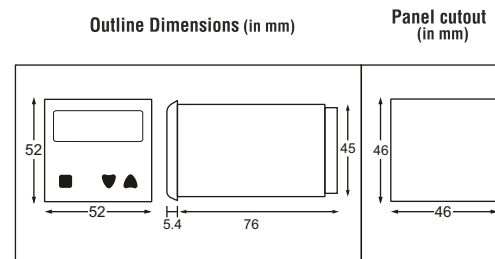

- Prepare the panel cutout with proper dimensions as shown above.
- Fit the unit into the panel with the help of clamp given.
- The equipment in its installed state must not come in close proximity to any heating sources, caustic vapors, oils, steam or other unwanted process by-products.
- Use the specified size of crimp terminals (M3.5 screws) to wire the terminal block. Tighten the screws on the terminal block using the tightening torque within the range of 1.2 N.m.
- Do not connect anything to unused terminals.

### 4. EMC GUIDELINES

- Use proper input power cables with shortest connections and twisted type.
- Layout of connecting cables shall be away from any internal EMI source.

### 5. LOAD CONNECTIONS

- The service life of the output relays depends on the switching capacity and switching conditions. Consider the actual application conditions and use the product within the rated load and electrical service life.
- Although the relay output is rated at 5 amps it is always necessary to use an interposing relay or contactor that will switch the load. This avoids damage to the controller in the event of a fault short developing on the power output circuit.
- Always use a separate fused supply for the "power load circuit" and do not take this from the live and neutral terminals supplying power to the controller.

### 6. ELECTRICAL PRECAUTIONS DURING USE

Electrical noise generated by switching of inductive loads can create momentary disruption, erratic display, latch up, data loss or permanent damage to the instrument.

- To reduce noise :**
- Use of snubber circuits across loads as shown above, is recommended.
  - Use separate shielded wires for inputs.

### 7. TERMINAL CONNECTIONS

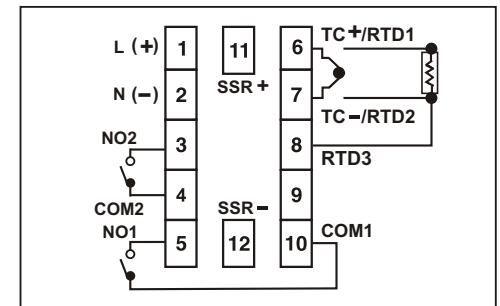

Use only the correct thermocouple wire or compensating cable from the probe to instrument terminals avoiding joints in the cable if possible. Failure to use the correct wire type will lead to inaccurate readings. Ensure that the input sensor connected at the terminals and the input type set in the temperature controller configuration are the same.

## 8. FRONT PANEL DESCRIPTION

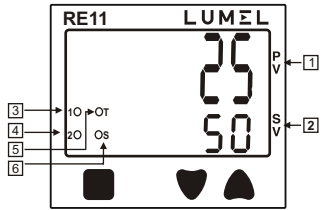

1	Process-value (PV) / Parameter name display	1) Displays a process value (PV). 2) Displays the parameter symbols at configuration mode/online menu. 3) Displays PV error conditions. (refer Table 2)
2	Parameter setting display	Displays the parameter settings at configuration mode/online menu.
3	Control output 1 indication	The LED is glow when the control output 1 is ON
4	Control output 2 indication	The LED is glow when the control output 2 is ON
5	Tune	Auto tune : Blinking (With faster rate) Self tune : Blinking (With slower rate)
6	Dwell timer	Blinking : Dwell timer is in progress. Continuous ON : Time over.

## 9. FRONT KEYS DESCRIPTION

FUNCTIONS	KEY PRESS
<b>ONLINE</b>	
To view Level 1	Press  key for 3 sec.
To view Level 2	Press  key for 3 sec.
To view Protection Level	Press  +  keys for 3 sec.
To view online parameters	Lower display selectable between SET1/SET2/TIME using  key.
<b>NOTE</b> : Elapsed time / Remaining time dependent on the selection of ONL parameter in level1.	
To change online parameter values	Press  +  /  to change parameter value.
<b>PROGRAMMING MODE</b>	
To view parameters on the same level.	or  key once to view the next or previous function in operational menu
To increase or decrease the value of a particular parameter.	+  to increase and  +  to decrease the function value. <b>Note</b> : Parameter value will not alter when respective level is locked.
NOTE : The unit will auto exit programming mode after 30 sec. of inactivity. OR By pressing the  or  or  +  keys for 3 sec.	

**Table 1 : INPUT RANGE**

FOR RTD			
INPUT TYPE	RANGE		
PT100	Resolution: 1	Resolution: 0.1	UNIT
	-150 to 850	-150.0 to 850.0	°C
	-238 to 1562	-199.9 to 999.9	°F

**FOR THERMOCOUPLE**

INPUT TYPE	RANGE		
J	Resolution: 1	Resolution: 0.1	UNIT
	-199 to 750	-199 to 750	°C
	-328 to 1382	-199 to 999	°F
K	-199 to 1350	-199 to 999	°C
	-328 to 2462	-199 to 999	°F
T	-199 to 400	-199 to 400	°C
	-328 to 750	-199 to 750	°F
R, S	0 to 1750	N/A	°C
	32 to 3182	N/A	°F

**Table 2 : ERROR DISPLAY**

When an error has occurred, the upper display indicates error codes as given below.

Error	Description	Control Output Status
SbP	Sensor break / Over range condition	OFF
SrE	Sensor reverse / Under range condition	OFF

## Programming online parameters

Setpoint 1	Default : 50
Range : SPLL to SPHL	
If upper display is selected as S E 1 then, Pressing  key will show on Upper display : S E 1 Lower display : <50> Press  +  /  keys to increment / decrement S E 1 value.	

Setpoint 2 / Dead band	Default : 0
Range : SPLL to SPHL	
If upper display is selected as S E 2 / d b then, Pressing  key will show on Upper display : S E 2 / d b Lower display : <0> Press  +  /  keys to increment / decrement S E 2 / d b value.	



Dwell Timer	Default : OFF
Range : OFF, 1 to 9999 min	
If upper display is selected as t. E n / t. E L P then, Pressing  key will show on Upper display : t. E n Lower display : <OFF> Press  +  /  keys to increment / decrement t. E n time value.	

## 10. USER GUIDE

**1. Display Bias** : This function is used to adjust the PV value in cases where it is necessary for PV value to agree with another recorder or indicator, or when the sensor cannot be mounted in correct location.

**2. Filter Time Constant** : The input filter is used to filter out quick changes that occur to the process variable in a dynamic or quick responding application which causes erratic control.

The digital filter also aids in controlling processes where the electrical noise affects the input signal.

Larger the value of FTC entered, greater the filter added and the slower the controller reacts to the process and vice versa.

**3. Auto tune (AT)** : The Auto-tuning function automatically computes and sets the proportional band (P), integral time (I), Derivative time (D), ARW% and cycle time (CY.T) as per process characteristics.

- Tune LED blinks at faster rate when auto-tuning is in progress.
- At the completion of Auto-tuning, Tune LED stops blinking.

**PID - time proportioning with auto reset & rate**

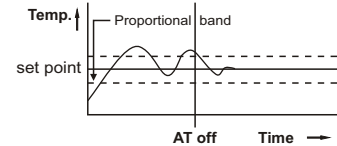

- If the power goes OFF before auto-tuning is completed, auto-tuning will be restarted at next power ON.
- If auto-tuning is not completed after 3-4 cycles, the auto-tuning is suspected to fail. In this case, check the wiring & parameters such as the control action, input type, etc.
- Carry out the auto-tuning again, if there is a change in setpoint or process parameters.

### 4. ON/OFF control action (For Reverse Mode) :

The relay is 'ON' up to the set temperature and cuts 'OFF' above the set temperature. As the temperature of the system drops, the relay is switched 'ON' at a temperature slightly lower than the set point.

### HYSTERESIS :

The difference between the temperature at which relay switches 'ON' and at which the relay switches 'OFF' is the hysteresis or dead band.

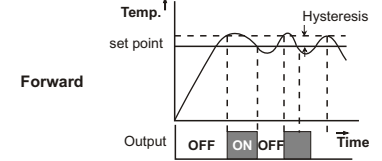
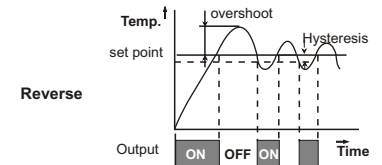

**5. Manual Reset (for PID control & I = 0)** : After some time the process temperature settles at some point and there is a difference between the set temperature & the controlled temperature. This difference can be removed by setting the manual reset value equal & opposite to the offset.

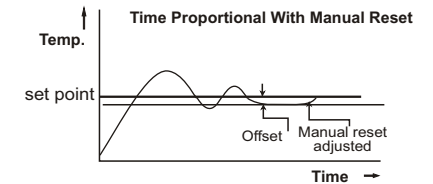

**6. Self Tune (ST)** : It is used where modification of PID parameters is required repeatedly due to frequent change in process condition eg. Setpoint.

- Tune LED blinks at slower rate when Self-tuning is in progress.
- At the completion of self-tuning, Tune LED stop blinking.

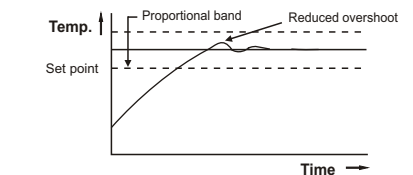

- Self-tuning is initiated under the following conditions :  
1) When setpoint is altered.  
2) When tune mode is altered. (TUNE=ST)
- ST will start only if PV < 50% of setpoint.
- ST will work only when ACT=RE.

## CONFIGURATION INSTRUCTIONS

KEY FUNCTIONS

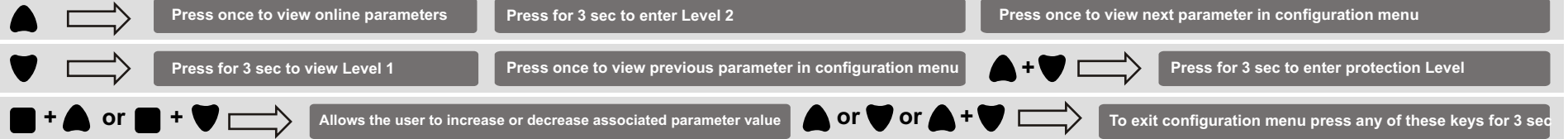

## OPERATIONAL MENU

POWER ON

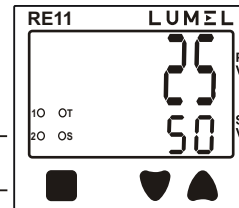

Press key for 3sec.

Press key for 3sec.

Press + keys for 3sec.

Level 1				
Display	Description	Default Value	Range	Display Condition
INPE	Input type (Refer Table 1)	J	J/K/T/R/S/RTD	—
RESL	Display Resolution	I	1/0.1	Not prompted for R & S type
UNIT	Temperature unit	°C	°C/°F	—
SPLL	Set point low limit	-199	Min range of sensor selected to SPHL	—
SPHL	Set point high limit	750	SPLL to Max range of sensor selected	—
FEC	Filter time constant	1.0	0.2 to 10.0 sec	—
RC1E	Control action for relay 1	PE	RE/FD	Not prompted for HC=YES
CNEL	Control logic	PID	PID/ONF	—
OUT	Control Output selection	REL	RELAY/SSR	—
DWEL	Dwell mode enable	NO	NO/YES	—
HC	Heat-cool mode selection	NO	NO/YES	—
RC2E	Control action for relay 2	PE	RE/FD/TIME	When HC=NO, TIME prompted when DWEL=YES
RD2	Relay 2 type	DEV	DEV/ABS	When ACT2=RE/FD
ONL	Online menu for timer	REMN	REMN/ELPS	When DWEL=YES
ARW	Anti-reset windup %	25.0	1.0 to 100.0%	When CNTL=PID
RS	Factory default (Reset all)	NO	NO/YES	—

Level 2				
Display	Description	Default Value	Range	Display Condition
TUNE	Tune (Refer user guide)	5E	OFF / ST / AT	For CNTL=PID
P	Proportional band	10	1.0 to 400.0°	For CNTL=PID
I	Integral time	120	0 to 9999 sec	For CNTL=PID
D	Derivative time	30	0 to 9999 sec	For CNTL=PID
CTM	Cycle time mode	RUE	AUTO/USR.F	For CNTL=PID
CT	Cycle time	150	0.1 to 99.9 sec	For CNTL=PID
HYS1	Hysteresis 1	1.0	0.1 to 99.9°	For CNTL=ONF
MNR	Manual reset	0.0	-19.9 to +19.9°	For CNTL=PID & I=0
PBC	Proportional band-cool	10	1.0 to 400.0°	For CNTL=PID & HC=YES
CTC	Cycle time-cool	150	0.1 to 99.9 sec	For CNTL=PID & HC=YES
HYS2	Hysteresis 2	1.0	0.1 to 99.9°	For HC=NO or HC=YES & CNTL=ONF
ETD	Dwell time	0FF	OFF, 1 to 9999 min	When DWEL=YES
DSB	Display bias	0.0	-19.9 to 19.9°	—

Protection Level				
Display	Description	Default Value	Range	Display Condition
SP1	Lock setpoint 1	UNL	UNLK/READ	—
SP2	Lock setpoint 2	UNL	UNLK/READ/LOCK	—
LUL1	Lock level 1	UNL	UNLK/READ/LOCK	—
LUL2	Lock level 2	UNL	UNLK/READ/LOCK	—
DWEL	Lock dwell time	UNL	UNLK/READ/LOCK	Prompted when DWEL=YES

### Note

- Locking parameters (LVL1 or LVL2 or SP or DWEL) will not permit change in the value of respective level parameters. **Time value (online) can be altered only when DWEL is not locked in protection level.**
- Continuous operation of + keys for SP or other parameters makes update speed faster in 3 stages after 3 sec.

**Note :** At power ON lower display shows (momentary) input type selected in Level 1.

**LUMEL S.A.**  
ul. Stubicka 4, 65-127 Zielona Góra, Poland  
tel.: +48 68 45 75 100, fax +48 68 45 75 508  
[www.lumel.com.pl](http://www.lumel.com.pl)

**Technical support:**  
tel.: (+48 68) 45 75 143, 45 75 141, 45 75 144, 45 75 140  
e-mail: [export@lumel.com.pl](mailto:export@lumel.com.pl)

**Export department:**  
tel.: (+48 68) 45 75 130, 45 75 131, 45 75 132  
e-mail: [export@lumel.com.pl](mailto:export@lumel.com.pl)

**Calibration & Attestation:**  
e-mail: [laboratorium@lumel.com.pl](mailto:laboratorium@lumel.com.pl)